

LSL6 CYCLOPS



Micro-directional luminaire with solid brass construction, features a Thermally Integrated® LED module and interchangeable acrylic optics. The easily replaceable, self-contained ball fits snugly into a precision machined socket for exceptional heat dissipation. Offered in 4 unique shroud configurations. Available as stake, flush, or surface mount. Downlight version also available.

DETAILS.

FINISHES AVAILABLE IN:

NAT – NATURAL

BLP – BRONZE LIVING PATINA

BLP-XD – BLP EXTRA DARK

*CUSTOM FINISHES AVAILABLE UPON REQUEST.

OVERALL SIZE: Ø1 5/8" X 2 5/8" H MAX

COLOR TEMPS AVAILABLE:

2700K, 3000K, AMBER

SHROUD OPTIONS:

60 - 60° ANGLED

NS - NO SHROUD

S90 - 90° SHORT

L 90 - 90° LONG

BEAM OPTIONS: 15°, 25°, 40°, ELLIPTICAL

IP67 – SUITABLE FOR WET LOCATIONS.

REMOTE LOW VOLTAGE TRANSFORMER REQUIRED -

DIMMABLE TO <10% (TRIAC/FORWARD PHASE)

*COMPATIBLE W/ 12V AC/DC MLV OR ELV TRANSFORMERS.

UL LISTED

**BRASS STAKE MOUNT AS STANDARD; OTHER OPTIONAL ACCESSORIES AVAILABLE.

LSL6 CYCLOPS

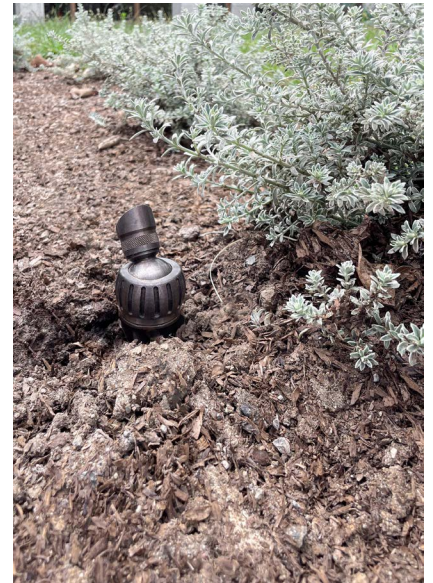

LSL6 CYCLOPS

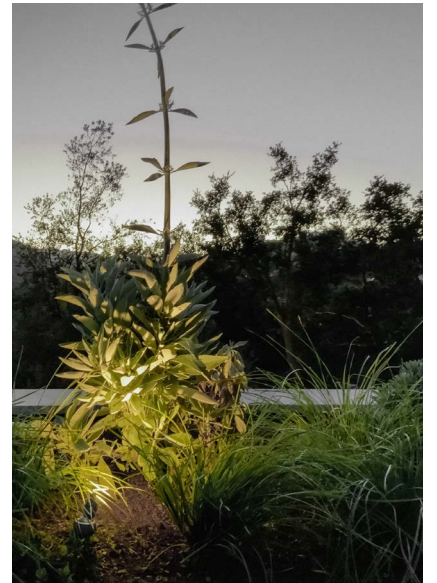
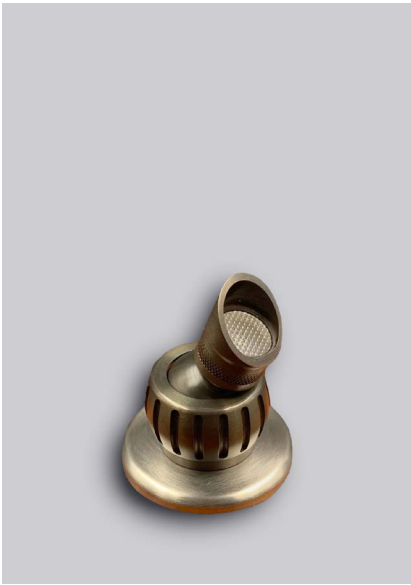

LSL6 CYCLOPS

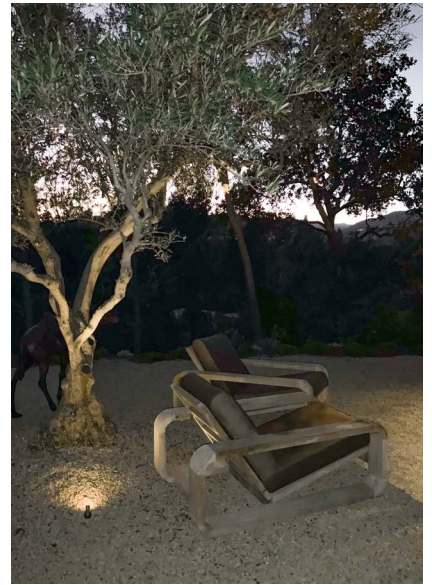
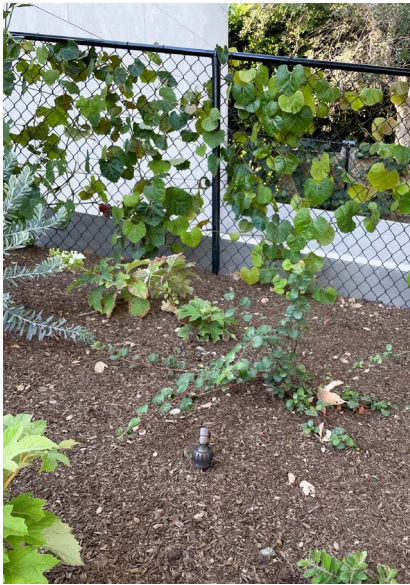
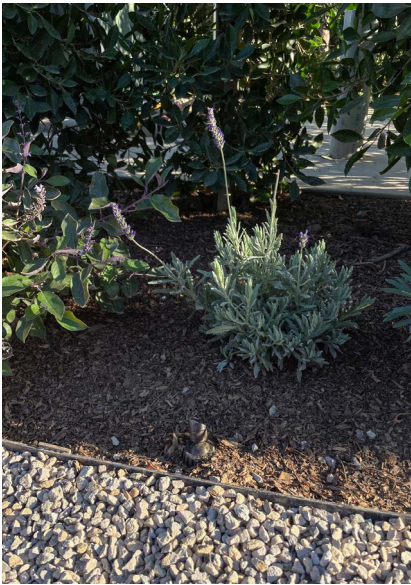

LSL6-1/2 CYCLOPS



Male Thread
BR-BLP
(Actual Size)

Auroralight's new LSL6 is a Micro-Directional X-Platform IP67 luminaire that features a Thermally Integrated® LED module. The machined ball and socket design incorporates a remarkably small yet capable Cree® powered light engine. The easily replaceable, self-contained ball fits snugly into a precision machined socket for exceptional heat dissipation allowing this tiny luminaire to operate at 3 watts. Offered in 4 unique configurations and 4 interchangeable optics; it is both inconspicuous and versatile.

Features include:

- 3 Watts and Up To 171 Lumens
- Cree XLAMP® High Density (XP-L) LED
- 2700K or 3000K (CRI 80 typ.)
- Thermally Integrated®
- 12V Integral Constant Current Driver (Remote 12V AC/DC Transformer Required)
- Dimmable to <10% (TRIAC/Forward Phase) via Compatible Transformer
- Compatible w/ 12V AC/DC ELV or MLV Transformers
- Solid Brass Construction
- US Patent No: D863,607 S

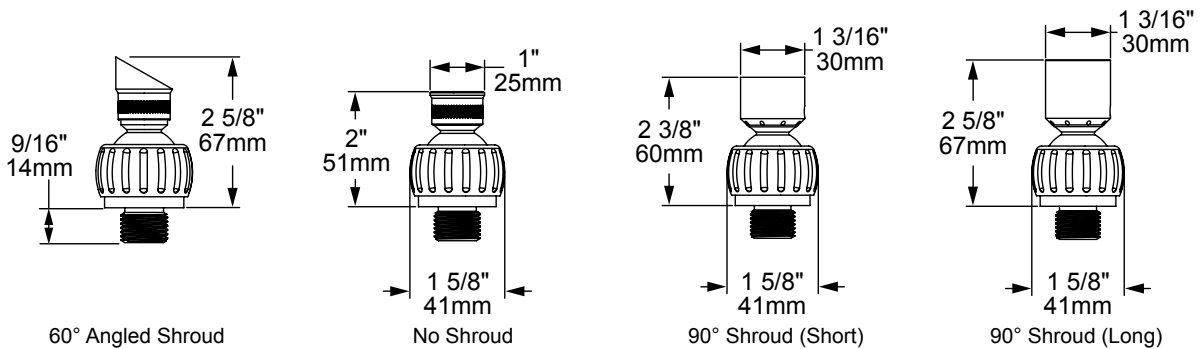

ALTERNATE CONFIGURATIONS AVAILABLE



LSL6-FM
Flush Mount



LSL6-SM
Surface Mount



LSL6-DL
Downlight

(SEE INDIVIDUAL CUT SHEETS FOR MORE INFO)



12V



SEE NEXT PAGE FOR ORDERING INFORMATION



LSL6-1/2 CYCLOPS



For smaller wattage and size options see **LSL10**, and **LSL8**
 For larger wattage and size options see **HSL20-LM**, **HSL16-LM**, and **HSL11-LM**

ORDERING GUIDE: LSL6-1/2 ^{Prefix} L (LED) SL (SPOTLIGHT) 6 (SERIES) - 1/2 (1/2" MALE THREAD)

INDICATES REQUIRED FIELD INDICATES OPTIONAL FIELD INCLUDED [_] QUICK SPEC (See Below)

QUICK SPEC SKU **LSL6-1/2-60-M-27-BMS-NAT**

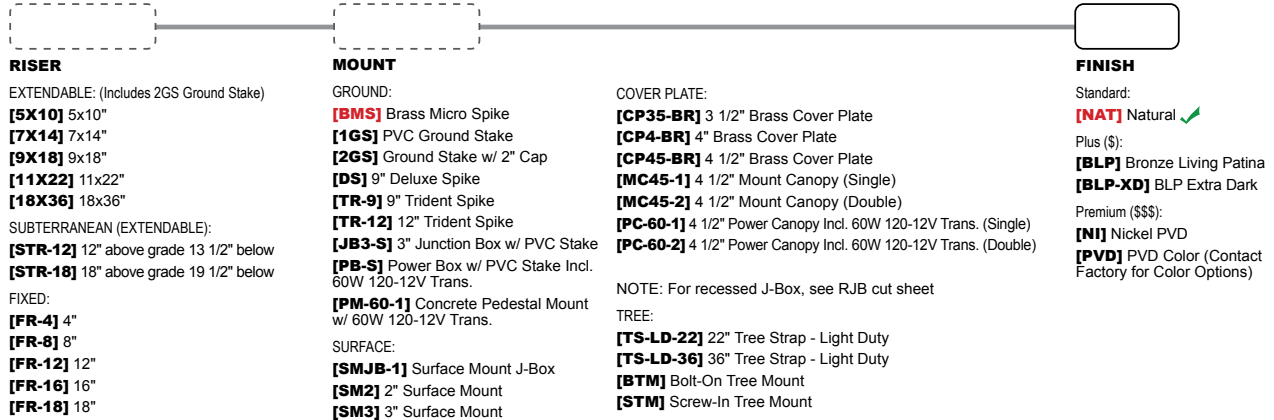
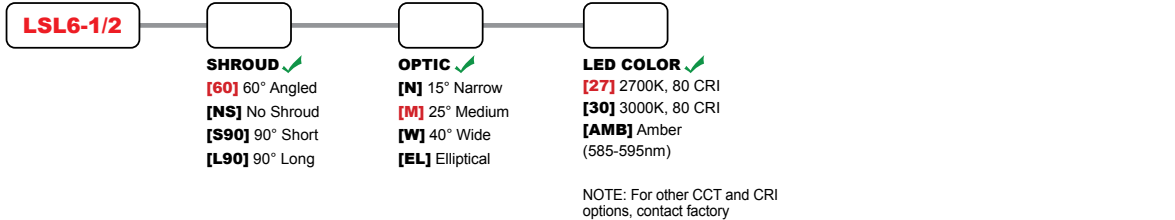

NOTE: Universal Adapter Included w/ Fixture. Most common configurations listed above. See product cut sheets for all options.

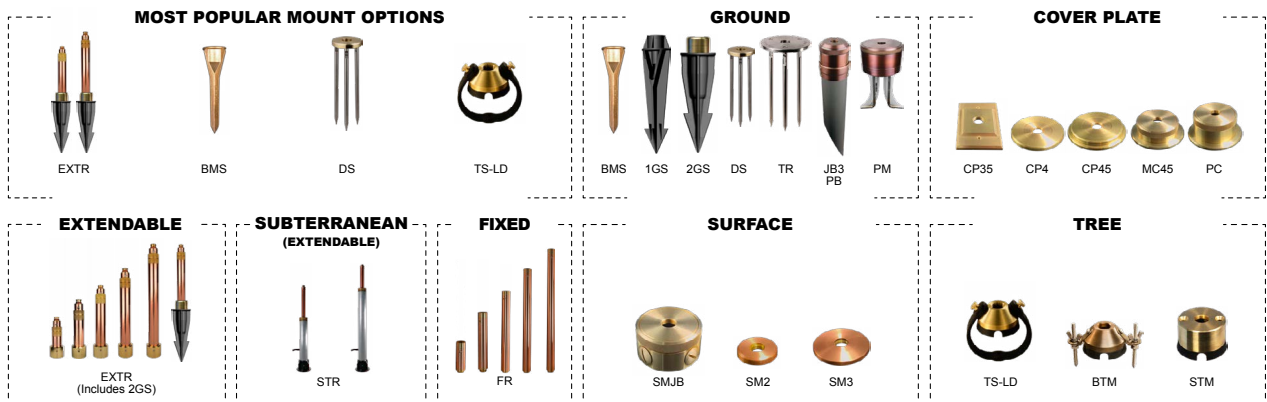

LSL6-1/2 CYCLOPS

PHOTOMETRIC OVERVIEW

3000K 15° (NARROW) OPTIC 145.5 LUMENS • CBCP 1279 AURORALIGHT LSL6-1/2-N-30		
30 FT	1.42	3.70
26 FT	1.89	3.21
22 FT	2.64	2.72
18 FT	3.95	2.22
14 FT	6.53	1.73
10 FT	12.8	1.23
6 FT	35.5	0.741
Distance From Fixture	Footcandles	Beam Width

3000K 25° (MEDIUM) OPTIC 171.4 LUMENS • CBCP 516 AURORALIGHT LSL6-1/2-M-30		
30 FT	0.574	12.1
26 FT	0.764	10.5
22 FT	1.07	8.88
18 FT	1.59	7.26
14 FT	2.63	5.65
10 FT	5.16	4.03
6 FT	14.3	2.42
Distance From Fixture	Footcandles	Beam Width

3000K 40° (WIDE) OPTIC 155.9 LUMENS • CBCP 275 AURORALIGHT LSL6-1/2-W-30		
30 FT	0.306	18.1
26 FT	0.407	15.7
22 FT	0.569	13.3
18 FT	0.850	10.8
14 FT	1.40	8.43
10 FT	2.75	6.02
6 FT	7.65	3.61
Distance From Fixture	Footcandles	Beam Width

