

HL-6500

Sleek square LED path light bollard. This fixture can be used as a path, sign, wall or surface mount. Available in 4 standard heights with custom heights upon request. Concrete mount also available.

DETAILS.

MATERIALS AVAILABLE IN:

MACHINED ALUMINUM

FINISHES AVAILABLE IN:

BK – BLACK POWDER COAT

BZ – BRONZE POWDER COAT

WT – WHITE POWDER COAT

AA – ANODIZED SATIN ALUMINUM

AP – ALUMINUM POWDER COAT

LED MODULE SIZE: 2" W X 2" D

STANDARD HEIGHT: 12"

STEM EXTENSION HEIGHT OPTIONS:

12", 15", 18", 24", 30"

LED OPTIONS, 3000K:

3W -OR- 8W

DIMMING: MLV

12VAC TRANSFORMER REQUIRED – NOT INCLUDED.

RATED FOR WET/DAMP/DRY LOCATIONS.

*OTHER ACCESSORIES AND MOUNTING OPTIONS AVAILABLE.

HL-6500

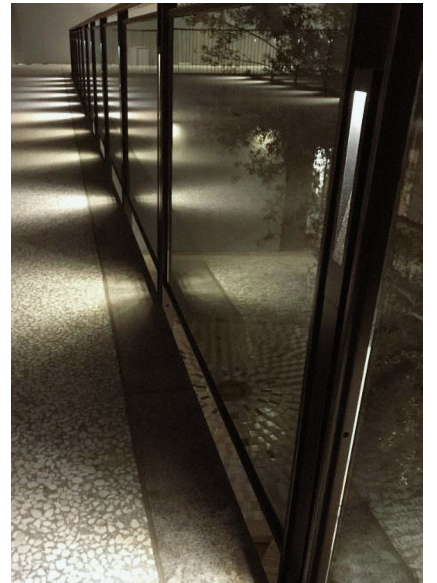
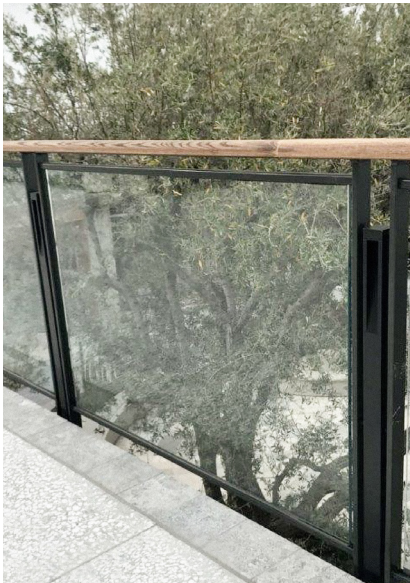
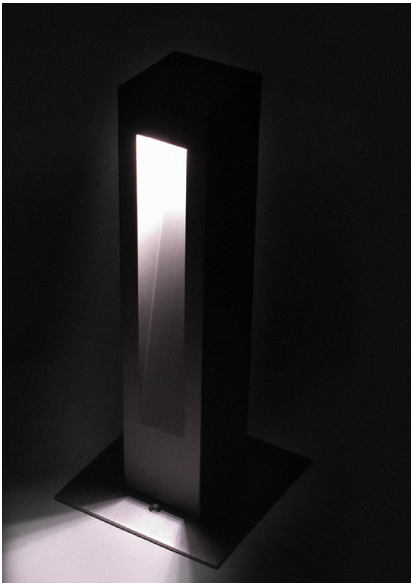
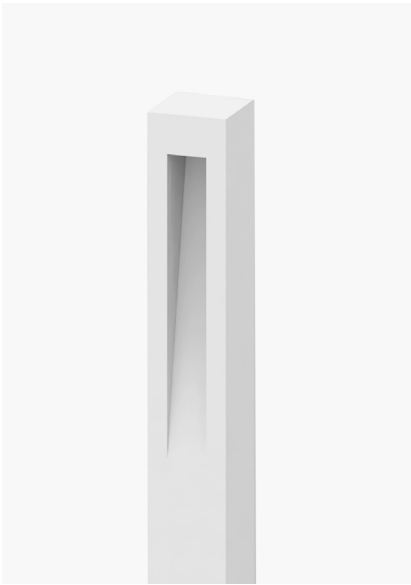

SPECIFICATIONS

DESCRIPTION:

Sleek square LED path light. Suitable for wet/damp/dry location installations.

MATERIAL:

Standard overall material is 6061 aluminum.

FINISH:

- AA - Anodized Satin Aluminum
- AP - Powder Coat Aluminum
- BK - Powder Coat Black
- BZ - Powder Coat Bronze
- WT - Powder Coat White

LED OPTIONS:

Integral high output LED, warm white (3000K CCT) standard, others available. LED is MLV dimmable.

- 3LED - 3W LED
- 8LED - 8W LED

VOLTAGE:

12 - 12 VAC output transformer required, not included.

MOUNTING:

Fixtures mount directly to standard Hevi Lite ground mounts with 1/2"-NPS thread. Fixtures with stem extensions mount directly to wood or concrete surfaces. Stem extensions are equipped with wiring compartment, (1) opening for 1/2" conduit or 1/2"-NPS mount and (4) 1/4" holes for concrete anchors.

- GM-1 - Composite mounting spike
- GM-2 - Cast mounting spike.
- GM-3 - Stainless steel triple prong spike.
- GM-4 - Stainless steel triple prong spike w/j-box
- GM-5 - ABS mounting spike w/ wiring compartment
- GM-6 - Cast mounting spike with wiring box
- GM-7 - Cork screw style mounting spike
- GM-8 - Cast in grade j-box
- GM-9 - Landscape power post

SIZES:

Standard fixture height is 12". Four standard stem extension available, custom lengths available upon request.

- 12 - 12" Overall Length
- 15 - 15" Overall Length
- 18 - 18" Overall Length
- 24 - 24" Overall Length
- 30 - 30" Overall Length

SAMPLE ORDER SPECIFICATION:

HL-6500-BZ-8LED-12-12

RATING:

Wet/damp/dry location.

MADE IN THE USA

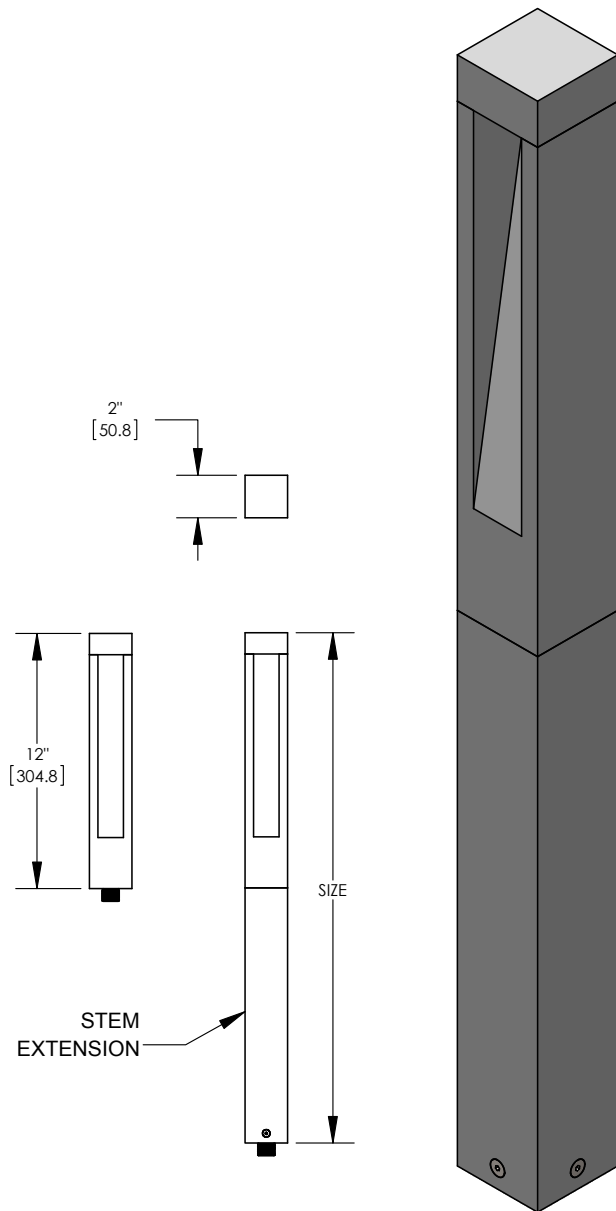

CATALOG NUMBER:

HL-6500

SPECIFICATIONS

DESCRIPTION:

Sleek square LED path light with concrete mount.
Suitable for wet/damp/dry location installations.

MATERIAL:

Standard overall material is 6061 aluminum.

FINISH:

- AA - Anodized Satin Aluminum
- AP - Powder Coat Aluminum
- BK - Powder Coat Black
- BZ - Powder Coat Bronze
- WT - Powder Coat White

LED OPTIONS:

Integral high output LED, warm white (3000K CCT)
standard, others available. LED is MLV dimmable.

- 3LED - 3W LED
- 8LED - 8W LED

VOLTAGE:

12 - 12 VAC output transformer required, not
included.

MOUNTING:

Fixtures mount directly to wood or concrete surfaces.
Stem extensions are equipped with wiring
compartment, (1) opening for 1/2" conduit and (4) 1/4"
holes for concrete anchors.

SIZES:

Four standard stem extension available, custom
lengths available upon request.

- 15 - 15" Overall Length
- 18 - 18" Overall Length
- 24 - 24" Overall Length
- 30 - 30" Overall Length

SAMPLE ORDER SPECIFICATION:

HL-6500-CM-BZ-8LED-12-24

RATING:

Wet/damp/dry location.

MADE IN THE USA

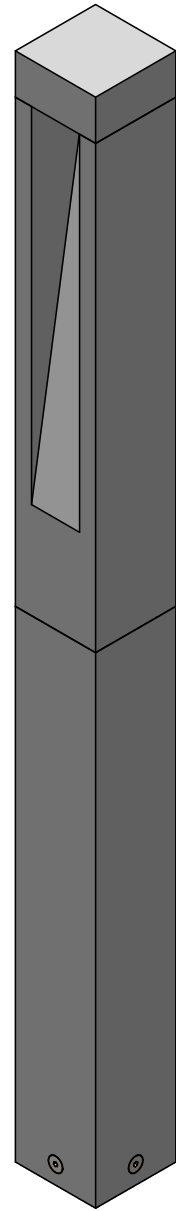
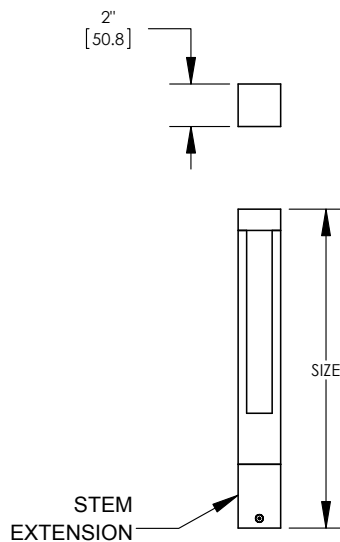

CATALOG NUMBER:

HL-6500-CM

Standard Finishes



AA - Anodized Satin Aluminum

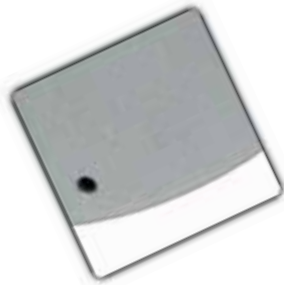

AP - Aluminum Powder Coat

Natural Finishes



N - Natural Brass

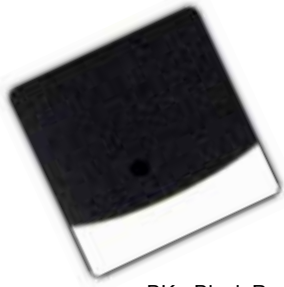

BK - Black Powder Coat

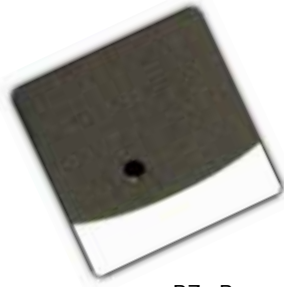

BZ - Bronze Powder Coat



N - Natural Stainless Steel



WT - White Powder Coat

Custom Finishes

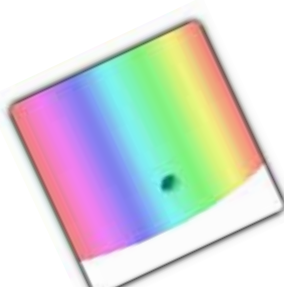

Custom Finishes

