



## FOSBURY

Floor and suspension LED lamp inspired after a visit to an exhibition by Alexander Calder.

### DETAILS.

FINISH: MATT BLACK

98.4" W; Ø5.9" X 5.9" H BASE

TOP SUSPENSION: 78.7" H

BOTTOM SUSPENSION: 157.5" H

15W LED 120V

3000K, 560 LM (DOWN) / 59 LM (UP)

\*AVAILABLE IN 2700K.

POWER SUPPLY WITH PLUG – BLACK CABLE

304 STAINLESS STEEL SUSPENSION CABLE

DUAL EMISSION - INDIRECT BLUE LIGHT (UP)

NOT DIMMABLE

FOSBURY

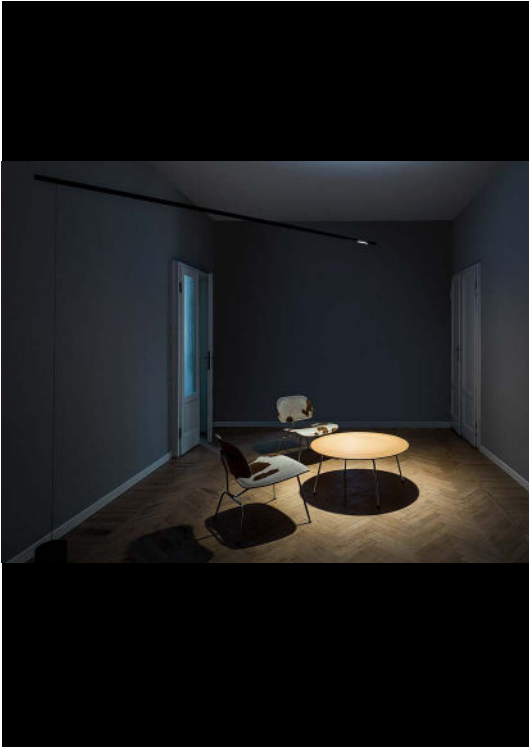

II PL

PLUGLIGHTING.COM  
INFO@PLUGLIGHTING.COM

5665 MELROSE AVENUE  
STE 108 LOS ANGELES 90038

P. 323 467 5635  
F. 323 467 5634

# FOSBURY



The sizes are expressed in millimeters / inches.

DESIGN DAVIDE GROPPI - 2014  
FLOOR AND SUSPENSION LAMP - METAL

FOSBURY

## EXTRADARK LUMINAIRE

### CEILING ROSE



### BASE

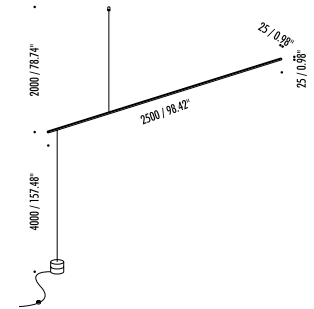

1A2590403.27.00	MATT BLACK - 2700K - ON/OFF	120 V - 60 Hz - 15 W LED - UGR <19 2700K - 525 lm (DOWN) - lm 59 (UP) - CRI >90 / 3000K - 560 lm (DOWN) - lm 59 (UP) - CRI >90
1A2590403.30.00	MATT BLACK - 3000K - ON/OFF	DUAL EMISSION - INDIRECT BLUE LIGHT (UP)
		304 STAINLESS STEEL SUSPENSION CABLE - BLACK CABLE
		POWER SUPPLY WITH PLUG
		OPTIONAL ACCESSORIES SUSPENSION KIT

II PL

PLUGLIGHTING.COM  
INFO@PLUGLIGHTING.COM





5665 MELROSE AVENUE  
STE 108 LOS ANGELES 90038

P. 323 467 5635  
F. 323 467 5634

FOSBURY



OPTIONAL ACCESSORIES

1A051000.00.00	STANDARD	SLOPED CEILING FIXING KIT - NICKEL PLATED - 1 PIECE	
		COMPATIBLE LAMPS: MASAI - FOSBURY - MOON 120	
1A052000.00.00	STANDARD	SLOPED ROSE FIXING KIT - NICKEL PLATED - 1 PIECE	
		COMPATIBLE LAMPS: MOON 60 - MOON 60 DE - MOON 80	
1A053000.00.00	STANDARD	SLOPED CEILING FIXING HOOK - CHROME PLATED - 1 PIECE	
		COMPATIBLE LAMPS: SIMBIOSI - SHANGHAI	
1A327000.00.00	MATT WHITE	CLAMP - 1 PIECE	
1A327040.00.00	MATT BLACK		

SUSPENSION KIT

# FOSBURY

1A0510000.00.00 - SLOPED CEILING FIXING KIT

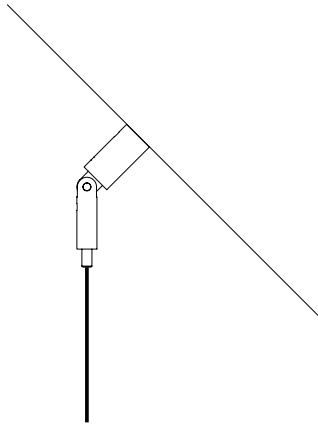

1A0530000.00.00 - SLOPED CEILING FIXING HOOK

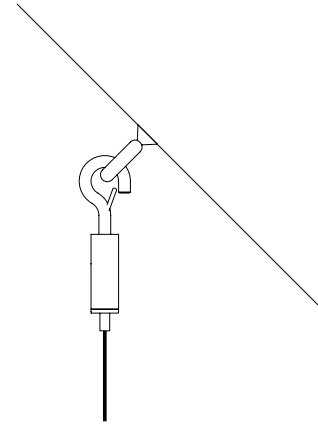

1A0520000.00.00 - SLOPED ROSE FIXING KIT

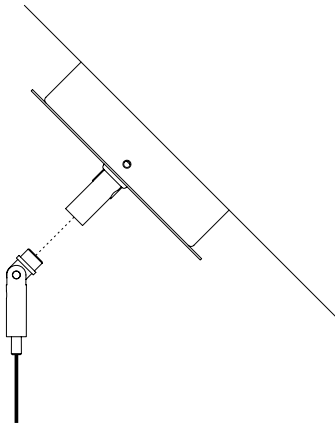

SUSPENSION KIT

**II PL**

PLUGLIGHTING.COM  
INFO@PLUGLIGHTING.COM

5665 MELROSE AVENUE  
STE 108 LOS ANGELES 90038

P. 323 467 5635  
F. 323 467 5634